

PREBENT MOUNTING EAR
(WHEN SPECIFIED)

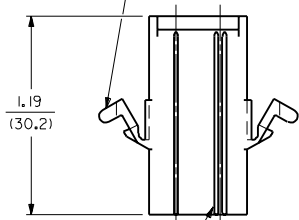

CIRCUIT NUMBER
IDENTIFICATION RIBS

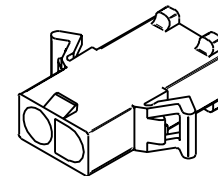
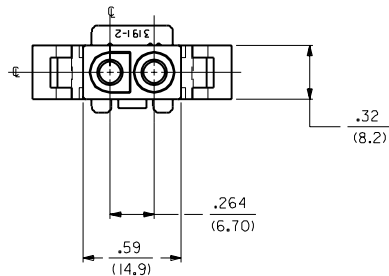
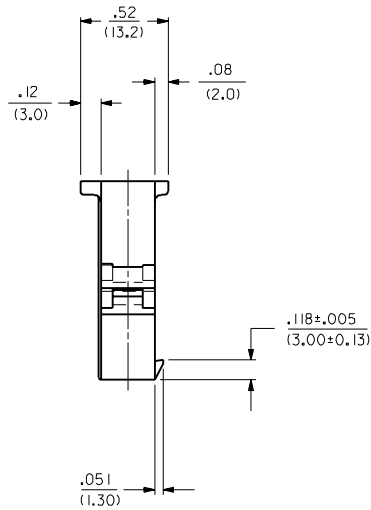

PLUG

3	E2	
2	D	
1	E4	
<input checked="" type="checkbox"/>	SH.	REV. LTR. REVISIONS

DIMENSIONS SHOWN METRIC (INCH)		▽ = 0	▼ = 0	REVISE ONLY ON CAD SYSTEM	
UNLESS OTHERWISE SPECIFIED TOLERANCES: ANGULAR ± .001 TO		TITLE .093/(2.36) HOUSING, PLUG AND RECEPTACLE, 2 CKT ± .264/(6.70) CTRS.			
INCH METRIC		PART NO.		DRAWG. NO.	
3 PLACE ± .010	---	L15LEJLL.		60532	
2 PLACE ± .014	± 0.25	MOLEX INCORPORATED		SHEET NO. DATE	
1 PLACE ---	± 0.35	U.S.A.		1 of 3 11/21/88	
DRAFT WHERE APPLICABLE MUST REMAIN WITHIN DIMENSIONS		SEE CHART		SD-3191-2*	
DRWG. BY: CEP	CHKD. BY: RW	FILE NAME: S31912X1	DRWG. NO.:	REV.:	SIZE:
APP'D. BY: RAS	SCALE: 2 : 1	DATE:			CP C

E4	REVISED UCR 98-0148 WANG 98-04-15
E3	ADD RAMP DIM'S ECN #U4 0293 3-1-94 RW
E2	X-REMOVE ECR U3 0001 GC 12/30/92 RW
E1	REL. RED VERSIONS ECR U1 2167 GC 1/24/92 RW
E	REV. MATL. CODE ECR # U90901 KBW 01-25-89 RW
D	REV. & REDRAWN ECR UB 1858 GEP 11-21-88 RW

NO P.S. 1

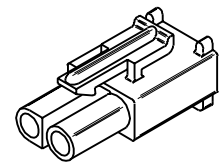
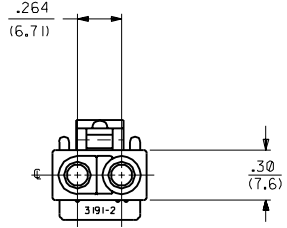
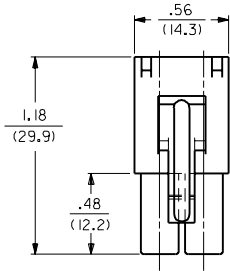
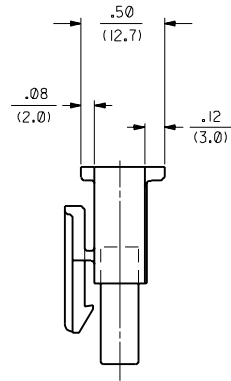
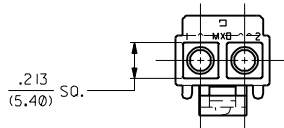

RECEPTACLE

DIMENSIONS SHOWN METRIC (INCH)		REVISIONS	
UNLESS OTHERWISE SPECIFIED TOLERANCES: ANGULAR ± .005° TO		D	
INCH METRIC		SEE SHT. 1	
3 PLACE ± .010	---		
2 PLACE ± .014	± 0.25		
1 PLACE ---	± 0.35		
DRAFT WHERE APPLICABLE MUST REMAIN WITHIN DIMENSIONS			
DRWG. BY: RAS	CHKD. BY: RW		
APP'D. BY: RAS	SCALE: 2:1		

TITLE		REVISIONS	
.093/(2.36) HOUSING, PLUG AND RECEPTACLE, 2 CKT., .264/(6.70) CTRS.		D	
MOLEX INCORPORATED		SEE SHT. 1	
LITLLEJ.L.L.	60532		
U.S.A.	2		
DATE	11/21/88		
PART NO.	SD-3191-2*		
DRWG. NO.			
FILE NAME	531912X2		
THIS DRAWING CONTAINS INFORMATION THAT IS PROPRIETARY TO MOLEX INC. AND SHOULD NOT BE USED WITHOUT WRITTEN PERMISSION.			

